

Surge arresters – ETITEC

ETITEC surge arresters are intended for protection of electrical installations and devices against overvoltage effects, which may occur in atmospheric discharges and switching overvoltages. The main part of surge arrester is ZnO non-linear varistor. Its main characteristic is ohmic nonlinearity, which depends strongly on the applied voltage at the clamps. All arresters have modular construction, a special feature is interchanging varistor part and visual signalization for varistor thermal failure. The signalization performed with a red flag, which appears when failure occurs. The models with RC mark are equipped with auxiliary contacts for signalization. ETI also provides SPD protection for PV systems - see Green Protect catalogue.

Common power distribution systems (Europe)

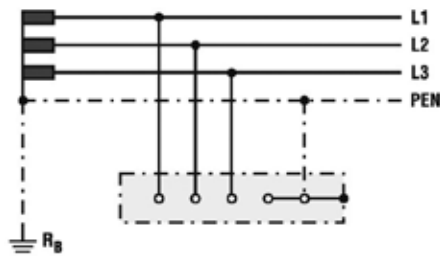

TN-C system

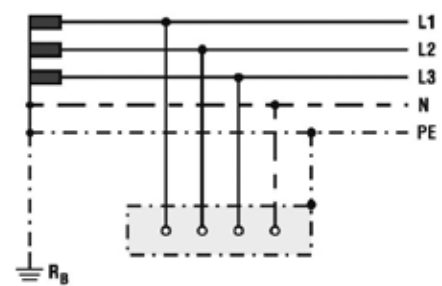

TN-S system

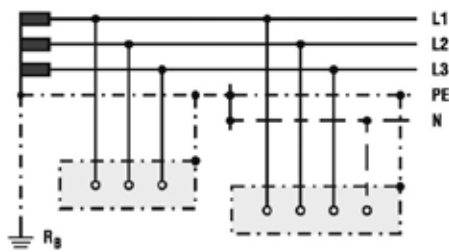

TN-C-S system

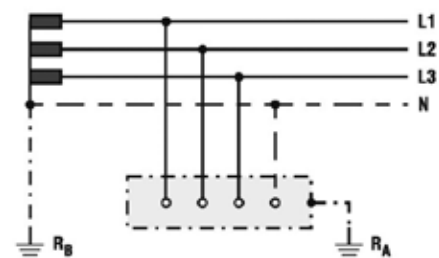

TT system

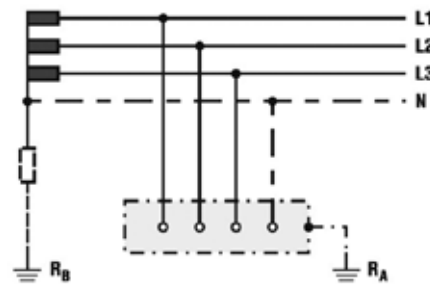

IT system

Surge arresters group B, B-F

ETITEC B is surge arrester for indoor application. Group B overvoltage protection is in accordance with VDE class B, C. This protection corresponds to IEC category I, II. The protection is made on the main distribution box, as the first level of protection against lightning strikes, partial direct, indirect atmospheric discharges and induced surges. In case of permanent arrester damage, thermal protection is activated which signalizes faulty arrester. Consequently only the varistor overvoltage insert has to be replaced. The basic casing remains in the top hat fixing DIN rail. ETITEC B 230/100G is an overvoltage arrester for protection against partial direct and indirect atmospheric discharges. It is used as a galvanic separation between N-PE conductor in TT systems.

Advantages:

- indication window of faulty device
- two module system (in case of a failure of one of the modules protection is still possible)
- remote signalisation
- mounting on DIN rail
- connection up to 35mm²
- high discharge currents
- high degree of protection
- varistor is the protective element

Technical data ETITEC B, ETITEC B-RC

Type	275/25	440/25	275/35	440/35	275/50	320/50	440/50
In accordance with	IEC-61643-1						
Category (IEC/VDE)	I, II / B, C						
Max. continuous operating voltage (AC/DC) U_c	275/350V	440/580V	275/350V	440/580V	275/350V	320/420V	440/580V
Nominal discharge current (8/20) I_n	25 kA						
Max. discharge current (8/20) I_{max}	100 kA						
Impulse current (10/350) I_{imp}	25 kA		35kA			50kA	
Specific energy	156kJ/Ω		306kJ/Ω			625kJ/Ω	
Charge	12.5As		17.5As			25As	
Protection level U_p - at I_n (8/20)	< 1.3kV	< 2.0kV	< 1.2kV	< 1.9kV	< 1.2kV	< 1.2kV	< 1.9kV
Residual voltage U_{res} - at I_{imp}	< 1.2kV	< 1.8kV	< 1.2kV	< 1.8kV	< 1.2kV	< 1.2kV	< 1.8kV
Follow current I_f	x						
Response time tA	< 25 ns						
Thermal protection	✓						
Back-up fuse (if mains > 250 A, 315A, 500A)	250 A/gL		315A gL			500 A/gL	
Short-circuit withstand current	25 kA/50 Hz						
Temperature range	-40°C ... +80°C						
Terminal screw torque	max. 4.5Nm						
Terminal cross section	35mm ² (solid)/25mm ² (stranded)						
Mounting EN 60715	35mm top-hat rail						
Degree of protection	IP20						
Housing material	thermoplastic; extinguishing degree UL 94 V-0						
Additional data for ETITEC B-RC							
Remote contacts	✓						
Contact ratings	AC: 250V/0,5A; 125V/3A						
Terminal cross section	max. 1.5 mm ²						
Remote terminal torque	0,25Nm						

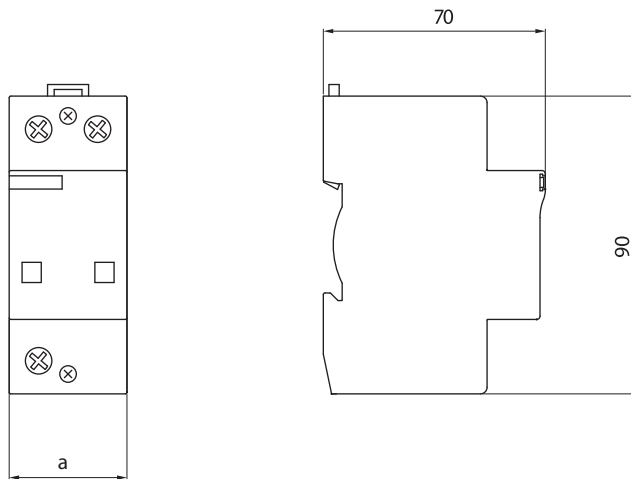

Dimensions	
ETITEC B	a
275/25	36
440/25	36
275/35	36
440/35	54
275/50	36
320/50	36
440/50	72

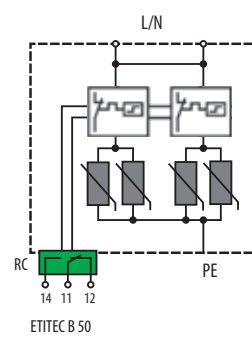
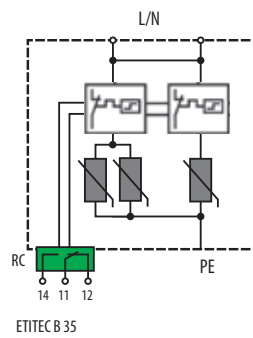
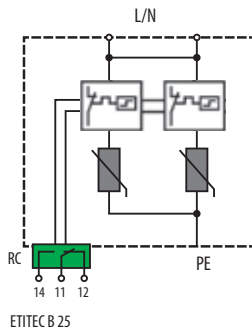
Technical data ETITEC B 100G

Type	ETITEC B 230/100G
In accordance with	IEC-61643-1
Category IEC / VDE	I, II / B, C
Max. continuous operating voltage (AC/DC) U_c	255 V
Nominal discharge current (8/20) I_n	100 kA
Max. discharge current (8/20) I_{max}	160 kA
Current peak value (10/350) I_{peak}	100 kA
Specific energy	2.5 MJ/W
Charge	50 As
Protection level Up	
- at I_n (8/20)	/
- at (1.2/50)	1.2 kV
Follow current I_f	100 ARMS
Response time t_A	100 ns
Torque	max. 4.5 Nm
Temperature range	-40°C ... +80°C
Cross-section of connection wire	single-strand 35 mm ² ; multi-strand 25 mm ²
Mounting	indors on top hat fixing rail 35 mm
Degree of protection	IP 20
Casing material	thermoplastic; extinguishing degree UL 94 V-0
Dimensions	DIN 43880 2TE

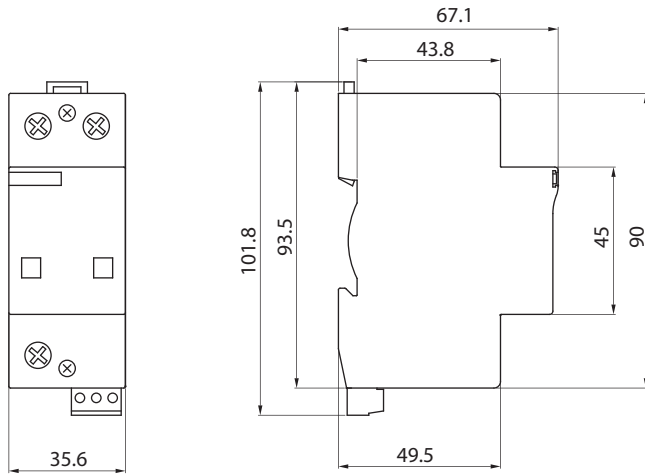

ETITEC B 230/100G

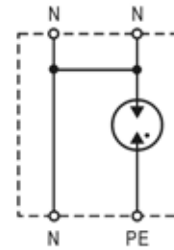

ETITEC B 230/100G

Technical data ETITEC B-F, ETITEC B-F-RC			
Type	150/12,5F	275/12,5F	320/12,5F
In accordance with	IEC-61643-1		
Category (IEC/VDE)	I, II / B, C		
Max. permitted operating voltage (AC/DC) U _c	150/200 V	275/350 V	320/420 V
Nominal discharge current (8/20) I _n	25 kA	25 kA	25 kA
Max. discharge current (8/20) I _{max}	50 kA	50 kA	50 kA
Nominal discharge current (10/350) I _{imp}	12,5 kA	12,5 kA	12,5 kA
Protection level Up - at I _n (8/20)	<1,0 kV	<1,6 kV	<1,6 kV
Response time	< 25 ns		
Back-up fuse (if mains > 160 A)	160 AgL		
Short-circuit capability to	25 kA/50 Hz		
Temperature range	- 40°C...+80°C		
Cross-section of connection wire	single-strand 35 mm ² ; multi-strand 25 mm ²		
Mounting	indors on top hat fixing rail 35 mm		
Degree of protection	IP20		
Casing material	thermoplastic; extinguishing degree V-0		
Additional data for ETITEC B-F-RC			
Remote signalisation	✓		
Switching capability	125 V/3 A		
Cross-section of connection wire	max. 1.5 mm ²		

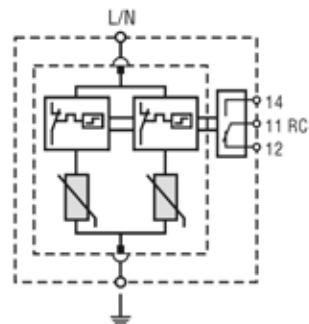

ETITEC B-F 12,5

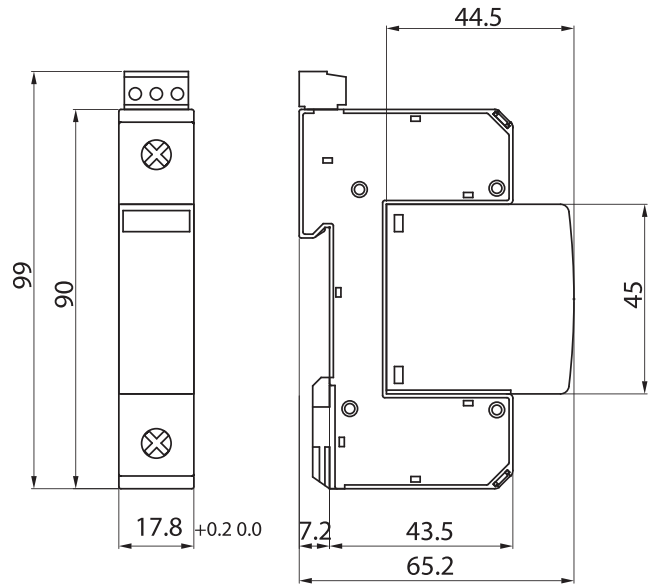

ETITEC B-F