



EFI-P

New Series of Residual Current Circuit Breakers

With automated 100% control of all key parameters of each product



Increased reliability

**Reduced power dissipation
by up to 45%**

Thinking of safety - so you don't have to



Selection of the Correct Type of RCCB

Simple household installations without electronic components



Household installations with electronic components (LCD TV, computers, printers, wash machines, ...)



Surge current proof 3kA (8/20µs). High immunity against unwanted tripping For S: ensuring selectivity in case of serially connected RCD's



AC type - Instantaneous

$I_n = 25, 40, 63, 80 \text{ \& } 100A$
 $I_{\Delta n} = 30, 100, 300, 500mA$
 2p & 4p

A type - Instantaneous

$I_n = 25, 40, 63, 80 \text{ \& } 100A$
 $I_{\Delta n} = 30, 100, 300, 500mA$
 2p & 4p

A type – G/KV (short-time delay) & S (selective)

$I_n = 25, 40, 63, 80 \text{ \& } 100A$
 $I_{\Delta n} = 30, 100, 300mA \text{ for K and } I_{\Delta n} = 100, 300mA \text{ for S}$
 2p & 4p

K/G – short time delay: time delayed min. 10ms and max. 40ms

S – selective: time delayed min. 40ms and max. 150ms

B type – Instantaneous (Tripping values are defined up to 1kHz)

$I_n = 25, 40, 63A$
 $I_{\Delta n} = 30, 100, 300 \text{ mA}$
 4p

B type – G/KV (short-time delay) & S (selective)

$I_n = 25, 40, 63A$
 $I_{\Delta n} = 30, 100, 300mA \text{ for K and } I_{\Delta n} = 100, 300mA \text{ for S}$
 4p

K/G – short time delay: time delayed min. 10ms and max. 40ms

S – selective: time delayed min. 40ms and max. 150ms

B+ type – Instantaneous (Tripping values are defined up to 20kHz and they are below

$I_n = 25, 40, 63A$
 $I_{\Delta n} = 30, 100, 300 \text{ mA}$
 4p



*For G/KV, S, B type and B+ type versions please see our general catalogue

Installations where 3f frequency converters and speed regulated machines are used (elevators, cranes).
 PV systems on a.c. side, Charging stations for electric vehicles, UPS, computer data centres, X-ray devices

Surge current proof 3kA (8/20µs) High immunity against unwanted tripping For S: ensuring selectivity in case of serially connected RCD's

Requirement for increased fire protection according to VDE 0664-400



Computer data centres



420mA) according to VDE 0664-400

Advantages of the new EFI-P

✎ Individual test measurements and other production data for each device can be read from the QR code, as well as instruction manuals and other technical materials

✎ Power dissipation per pole reduced by up to 45%

✎ High mechanical endurance: > 10.000 cycles

✎ High electrical endurance: > 4.000 cycles

✎ All necessary technical & installation information can be found on the front and side of the device

✎ Basic installation requirements are engraved into housing

✎ All important components are marked with a QR code, containing individual test results and thus ensuring exact traceability and highest quality control

✎ Better protection of terminals against touching the parts under voltage

✎ Patented two-step mechanism for max reliability of operation

✎ Dimensionally the same as old EFI, making replacement effortless

✎ Special versions available:
- RCCB for use in 110, 125 & 127 V systems
- RCCB with neutral pole on the left side for 4M version

✎ The terminals accept not only wires but also time saving busbars

✎ RCCBs can be supplied with single phase and three phase busbars

✎ Supply is possible both from top and bottom terminals

✦ Fully automated assembly line, enabling more intermediate measurements during assembly process to ensure best functionality of final product



✦ Due to dimensional and construction similarity, all EFI accessories can also be used with EFI-P



✦ Improved housing attachment with sealed screws

✦ Rated conditional short-circuit current: 10 kA



✦ Reset version: in case of differential current, the button moves to the "trip" (middle) position. In case of manual turn off, the button moves to the "off" (lowest) position.

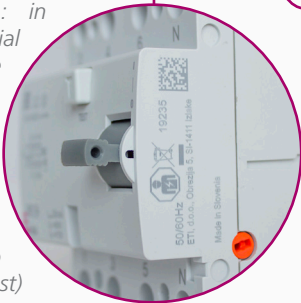

✦ Test button enables user to check residual functionality



✦ Real contact position indication for easier identification, whether RCCB is in ON or OFF position

✦ Clearly marked terminals to ensure appropriate connection



EFI-P2 AC & A Instantaneous & EFI-P2R A Instantaneous

I _n	I _{Δn}	Nr. of poles	AC type		Weight	Pack.	
			Instantaneous	A type			
[A]	[A]		Instantaneous	Instantaneous	Instantaneous Reset*	[g]	[pcs]
16	0,03	2	002061210	002061110	002061460	175	1/54
25	0,03	2	002061211	002061111	002061461	175	1/54
40	0,03	2	002061212	002061112	002061462	175	1/54
63	0,03	2	002061213	002061113	002061463	190	1/54
80	0,03	2	002061214	002061114	002061464	190	1/54
16	0,1	2	002061220	002061120	002061470	175	1/54
25	0,1	2	002061221	002061121	002061471	175	1/54
40	0,1	2	002061222	002061122	002061472	175	1/54
63	0,1	2	002061223	002061123	002061473	190	1/54
80	0,1	2	002061224	002061124	002061474	190	1/54
16	0,3	2	002061230	002061130	002061480	175	1/54
25	0,3	2	002061231	002061131	002061481	175	1/54
40	0,3	2	002061232	002061132	002061482	175	1/54
63	0,3	2	002061233	002061133	002061483	190	1/54
80	0,3	2	002061234	002061134	002061484	190	1/54
16	0,5	2	002061240	002061140	002061490	175	1/54
25	0,5	2	002061241	002061141	002061491	175	1/54
40	0,5	2	002061242	002061142	002061492	175	1/54
63	0,5	2	002061243	002061143	002061493	190	1/54
80	0,5	2	002061244	002061144	002061494	190	1/54

Instantaneous Reset version: in case of differential current, the button moves to the "trip" (middle) position. In case of manual turn off, the button moves to the "off" (lowest) position.

For use in 127V system

Rated residual current

0,03; 0,1; 0,3A

Rated current

16-80A

If RCCBs will be used in lower than standard system voltage (for instance 110V or 125V, as is the case in Caribbean) EFI-P A127V must be used to ensure correct test button functionality.

**EFI-P2 A 127V**

I_n [A]	$I_{\Delta n}$ [A]	Nr. of poles	For use in 127V system A type	Weight [g]	Pack. [pcs]
16	0,03	2	002061350	175	1/54
25	0,03	2	002061351	175	1/54
40	0,03	2	002061352	175	1/54
63	0,03	2	002061353	190	1/54
80	0,03	2	002061354	190	1/54
16	0,1	2	002061360	175	1/54
25	0,1	2	002061361	175	1/54
40	0,1	2	002061362	175	1/54
63	0,1	2	002061363	190	1/54
80	0,1	2	002061364	190	1/54
16	0,3	2	002061370	175	1/54
25	0,3	2	002061371	175	1/54
40	0,3	2	002061372	175	1/54
63	0,3	2	002061373	190	1/54
80	0,3	2	002061374	190	1/54

N on the left side

Rated residual current

0,03; 0,1; 0,3A

Rated current

16-80A

RCCB with neutral conductor on the left side enables you to use standard busbars for connection between RCCB and MCBs

**EFI-P2 A NL**

I_n	$I_{\Delta n}$	Nr. of poles	N on the left side	Weight	Pack.
[A]	[A]		A type	[g]	[pcs]
16	0,03	2	002061410	175	1/54
25	0,03	2	002061411	175	1/54
40	0,03	2	002061412	175	1/54
63	0,03	2	002061413	190	1/54
80	0,03	2	002061414	190	1/54
16	0,1	2	002061420	175	1/54
25	0,1	2	002061421	175	1/54
40	0,1	2	002061422	175	1/54
63	0,1	2	002061423	190	1/54
80	0,1	2	002061424	190	1/54
16	0,3	2	002061430	175	1/54
25	0,3	2	002061431	175	1/54
40	0,3	2	002061432	175	1/54
63	0,3	2	002061433	190	1/54
80	0,3	2	002061434	190	1/54

EFI-P4 AC & A Instantaneous & EFI-P4R A Instantaneous

I _n	I _{Δn}	Nr. of poles	AC type		Weight	Pack.	
			Instantaneous	A type			
[A]	[A]		Instantaneous	Instantaneous	Instantaneous Reset*	[g]	[pcs]
16	0,03	4	002061610	002061510	002061860	300	1/27
25	0,03	4	002061611	002061511	002061861	300	1/27
40	0,03	4	002061612	002061512	002061862	300	1/27
63	0,03	4	002061613	002061513	002061863	330	1/27
80	0,03	4	002062145*	002062545*	-	380	1/27
16	0,1	4	002061620	002061520	002061870	300	1/27
25	0,1	4	002061621	002061521	002061871	300	1/27
40	0,1	4	002061622	002061522	002061872	300	1/27
63	0,1	4	002061623	002061523	002061873	330	1/27
80	0,1	4	002063145*	002063545*	-	380	1/27
16	0,3	4	002061630	002061530	002061880	300	1/27
25	0,3	4	002061631	002061531	002061881	300	1/27
40	0,3	4	002061632	002061532	002061882	300	1/27
63	0,3	4	002061633	002061533	002061883	330	1/27
80	0,3	4	002064145*	002064545*	-	380	1/27
16	0,5	4	002061640	002061540	002061890	300	1/27
25	0,5	4	002061641	002061541	002061891	300	1/27
40	0,5	4	002061642	002061542	002061892	300	1/27
63	0,5	4	002061643	002061543	002061893	330	1/27
80	0,5	4	002065145*	002065545*	-	380	1/27

Instantaneous Reset version: in case of differential current, the button moves to the "trip" (middle) position. In case of manual turn off, the button moves to the "off" (lowest) position.

*Old version (EFI-4)

For use in 127V system

Rated residual current

0,03; 0,1; 0,3A

Rated current

16-63A

If RCCBs will be used in lower than standard system voltage (for instance 110V or 125V, as is the case in Caribbean) EFI-P A 127V must be used to ensure correct test button functionality.



EFI-P4 A 127V

I_n [A]	$I_{\Delta n}$ [A]	Nr. of poles	For use in 127V system A type	Weight [g]	Pack. [pcs]
16	0,03	4	002061750	300	1/27
25	0,03	4	002061751	300	1/27
40	0,03	4	002061752	300	1/27
63	0,03	4	002061753	330	1/27
16	0,1	4	002061760	300	1/27
25	0,1	4	002061761	300	1/27
40	0,1	4	002061762	300	1/27
63	0,1	4	002061763	330	1/27
16	0,3	4	002061770	300	1/27
25	0,3	4	002061771	300	1/27
40	0,3	4	002061772	300	1/27
63	0,3	4	002061773	330	1/27

N on the left side

Rated residual current

0,03; 0,1; 0,3A

Rated current

16-63A

RCCB with neutral conductor on the left side enables you to use standard busbars for connection between RCCB and MCBs

**EFI-P4 A NL**

I_n	$I_{\Delta n}$	Nr. of poles	N on the left side	Weight	Pack.
[A]	[A]		A type	[g]	[pcs]
16	0,03	4	002061810	300	1/27
25	0,03	4	002061811	300	1/27
40	0,03	4	002061812	300	1/27
63	0,03	4	002061813	330	1/27
16	0,1	4	002061820	300	1/27
25	0,1	4	002061821	300	1/27
40	0,1	4	002061822	300	1/27
63	0,1	4	002061823	330	1/27
16	0,3	4	002061830	300	1/27
25	0,3	4	002061831	300	1/27
40	0,3	4	002061832	300	1/27
63	0,3	4	002061833	330	1/27

Technical features

Technical data EFI Instantaneous type AC & A		
Type	EFI-P2 Instantaneous	EFI-P4 Instantaneous
Electrical		
Rated Voltage U_n	230 / 240 V AC	400/415V AC
Rated current I_n	16, 25, 40, 63, 80A	16, 25, 40, 63, 80A
Rated frequency f_n	50/60Hz	50/60Hz
Rated insulation voltage U_i	440V	440V
Rated impulse withstand voltage (1,2/50 μ s)	4kV	4kV
Peak withstand current (8/20 μ s)	400A	400A
Electrical isolation	> 4mm contact space	
Rated residual operating current I_{rn}	0,03; 0,1; 0,3 & 0,5A	0,03; 0,1; 0,3 & 0,5A
Rated conditional short-circuit current I_{cn}	10kA	10kA
Rated making and breaking capacity I_m	800A	630A (EFI-P4 63A) & 800A (EFI-4 80A)
Max back-up fuse for short circuit protection	80A gG	63A gG (EFI-P4 63A) & 80A gG (EFI-4 80A)
Voltage range test circuit	150-264V	150-264V
Min. operating voltage	voltage independent	voltage independent
Insulating class	B	B
Standards	IEC/EN 61008	IEC/EN 61008
Mechanical Endurance	> 10.000 cycles	> 10.000 cycles
Electrical endurance	> 4.000 cycles	> 4.000 cycles
Shock resistance	acc to IEC/EN 61008-1	acc to IEC/EN 61008-1
Resistance to vibrations acc. To IEC 60068-2-7	5g (50, 60 & 500Hz)	5g (50, 60 & 500Hz)
Mechanical		
Frame size	45mm	45mm
Device height	68mm (DIN rail acc to EN6071)	
Device width	36mm (2 x Module units)	72mm (4 x Module Units)
Degree of protection	IP20	IP20
Upper and lower terminals	open mounted/lift terminals	
Terminal capacity	1-25mm ²	1-25mm ²
Terminal screw	M5 (Pozidrive PZ2)	M5 (Pozidrive PZ2)
Terminal torque	max 3Nm	max 3Nm
Busbar thickness	0,8 - 2 mm	0,8 - 2 mm
Operating temperature	-25°C ... +55°C	-25°C ... +55°C
Storage and transport temperature	-40°C ... +70°C	-40°C ... +70°C
Resistance to climatic conditions	IEC/EN 61008	IEC/EN 61008
Contact position indicator	mechanical red/green	
Mounting position	any	
Mounting on the rail	35mm acc to EN50022	
Supply possibility	top or bottom	

In [A]	Power dissipation EFI-P2	Power dissipation EFI-P4
	P/pole [W]	P/pole [W]
16	0,46-0,51	0,48-0,62
25	1,22-1,27	1,27-1,52
40	3,48-3,72	4,14-5,00
63	2,14-2,58	2,45-3,00
80	3,53-3,82	

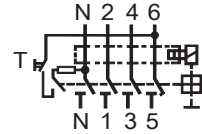
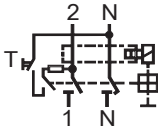
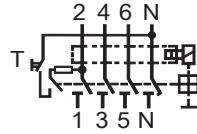

Version with N-pole on the left

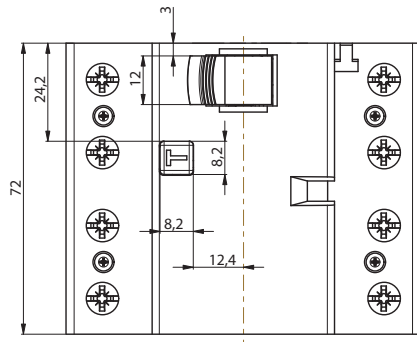
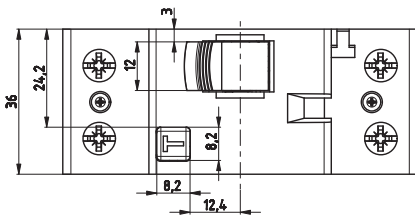
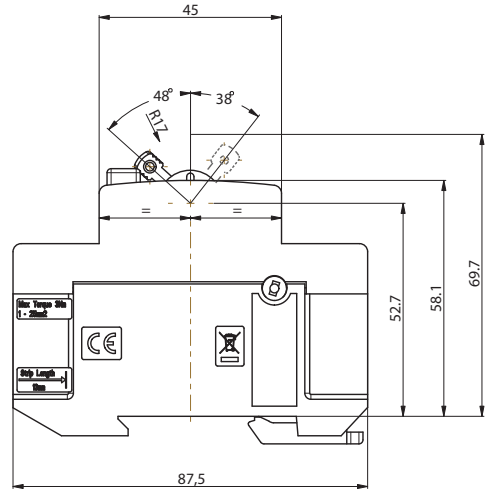
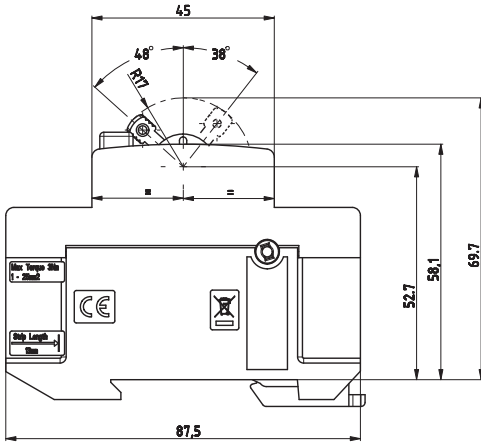

ETI group



www.etigroup.eu

PARENT COMPANY

ETI D.O.O.
Obrežija 5, 1411 Izlake, Slovenia
Phone: +386 3 5657 570
E-mail: eti@eti.si
<http://www.etigroup.eu>
<http://www.eti.si>

ETI POLAM SP. Z O.O.
Ul. Jana Pawła II 18, 06100 Pułtusk, Poland
Phone: +48 23 691 93 00
E-mail: etipolam@etipolam.com.pl
<http://www.etipolam.com.pl>

ETI HU ELEKTROTECHNIKAI, KFT.
Rokolya utca 25, 1131 Budapest, Hungary
Phone: +36 1 238 0784
E-mail: eti@eti-hu.hu
<http://www.eti-hu.hu>

ETI SARAJEVO D.O.O.
Hifzi Bjelevca 13, 71 000 Sarajevo, BiH
Phone: +387 33 77 52 50
E-mail: etisa@bih.net.ba
<http://www.eti.ba>

ETI RUSSIA
St. Ugreshskaya d. 2, Moscow, Russia
Tel: +7 (495) 665-34-80
E-mail: info@etirus.ru
www.etimoskva.ru

ASSOCIATED COMPANIES

ITALWEBER S.P.A.
Via Enrico Fermi 40/42, 20090 Assago, Italy
Phone: +39 02 939 771
E-mail: info@italweber.it
<http://www.italweber.it>

ETI ELEKTROELEMENT S.R.O.
Paceřícká 2773/1
9300 Praha - Horní Počernice
Phone: +420 777 950 203
E-mail: jan.tichy@etielektroelement.cz

ETI ROMANIA S.R.L.
Str. Doina, Nr. 17, Sector 5, Bucharest, Romania
Phone: +40 (0)21 317 1743
E-mail: eti.electrice@gmail.com
<http://www.etigroup.ro>

SUBSIDIARIES

ETI PROPLAST D.O.O.
Obrežija 5, 1411 Izlake, Slovenia
Phone: +386 3 56 57 590
E-mail: etiproplast@eti.si
<http://www.etiproplast.si>

ETI UKRAINE, LTD
Ul. Akademika Tupoleva 19,
04128 Kiev, Ukraine
Phone: +380 44 494 21 80
E-mail: office@eti.ua
<http://www.eti.ua>

ETI ELEKTROELEMENT D.O.O.
For technical engineering and store
of electrotechnical products
Ulica grada Vukovara 235/V,
10000 Zagreb, Croatia
<http://www.eti.si/hr>

ETI ELEKTROTECHNIK GMBH
Dorfwiesenweg 13, 63828 Kleinkahl, Germany
Phone: +49 6024 6397-0
E-mail: contact@eti-de.de
<http://www.eti-de.de>

ETIBALTUS, UAB
Tilzes 41a, 47187 Kaunas, Lithuania
Phone: +370 37 261 582
E-mail: info@etibaltus.lt
<http://www.etibaltus.lt>

ETI PROSTIK D.O.O.
Obrežija 5, 1411 Izlake, Slovenia
Phone: +386 3 56 57 463
E-mail: etiprostik@eti.si

ETI B
Zvečanska 56/17
11000 Beograd, Serbia
Phone: +381 (0)11 3961 688
E-mail: miodrag.stojkovic@etib.rs
<http://www.etib.rs>