

Miniature Electromagnetic Relays

DATA

Description

Electromechanical relay with 2x CO contacts in miniature housing. Can be used in PCB or with plug-in sockets.

- MER2 (2 pole CO »change over contact«, 2x8A AC1)
- Wide range of control voltages (AC coils: 24V and 230V, DC coils: 5V, 12V, 24V)
- Two types of plugin sockets (M type and T type)
- Accessories (retainer/retractor clips, RC modules...)
- Color: Grey

Features

- Cadmium - free contacts; height 15,7 mm
- 5000V / 10 mm reinforced insulation
- For PCB and plug-in sockets
- AC and DC coils
- Compliance with standard EN 60335-1
- RoHS

Table 1: Technical data

		MER2
Number and type of contacts		2 CO
Contact material		AgNi
Rated / max. switching voltage AC		250 V / 440 V
Min. switching voltage		5 V AgNi
Rated load (capacity)		
AC1		8 A / 250 V AC
AC15		3 A / 120 V 1,5 A / 240 V (B300)
AC3		550 W (single-phase motor)
DC1		8 A / 24 V DC (see Fig. 3)
DC13		0,22 A / 120 V 0,1 A / 250 V (R300)
Min. switching current		5 mA Agni
Rated current		8 A
Max. breaking capacity AC1		2000 VA
Min. breaking capacity		0,3 W AgNi
Contact resistance		≤ 100 mΩ
Max. operating frequency (cycles/hour)		
• at rated load AC1		600
• no load		72 000
Coil data		
Rated voltage	50/60 Hz AC DC	12 ... 240 V 3 ... 110 V
Must release voltage		AC: ≥ 0,15 U _n DC: ≥ 0,1 U _n
Operating range of supply voltage		See Tables 1, 2 and Fig. 4, 5
Rated power consumption AC		0,75 VA
DC		0,4 ... 0,48 W
Insulation according to EN 60664-1		
Insulation rated voltage		400 V AC
Rated surge voltage		4000 V 1,2 / 50 μs
Overvoltage category		III
Insulation pollution degree		3
Dielectric strength		
• between coil and contacts		5000 V AC type of insulation: reinforced
• pole - pole		2500 V AC type of insulation: basic
Contact - coil distance		
• clearance		≥ 10 mm
• creepage		≥ 10 mm
General data		
Operating / release time (typical values)		7 ms / 3 ms
Electrical life		
• resistive AC1		> 10 ⁵ 8 A, 250 V AC
• cosΦ		see Fig. 2
• DC L/R = 40 ms		> 10 ⁵ 0,15 A, 220 V DC
Mechanical life (cycles)		> 3x10 ⁷
Dimensions (L x W x H)		29 x 12,7 x 15,7 mm
Weight		14 g
Ambient temperature		
• storage		-40 ... +85 °C
• operating		AC: -40 ... +70 °C DC: -40 ... +85 °C
Cover protection category		IP40 / IP67
Environmental protection		RTII / RTIII
Shock resistance (NC)		20 g
Vibration resistance		5 g 10 ... 150 Hz
Solder bath temperature/ soldering time		max. 270 °C / max. 5 s

Table 2: Coil data

DC voltage version					
Coil code	Rated voltage V DC	Coil resistance at 20 °C Ω	Acceptable resistance	Coil operating range V DC	
				min. (at 20 °C)	max. (at 20 °C)
005DC	5	60	± 10%	3,5	12,7
012DC	12	360	± 10%	8,4	30,6
024DC	24	1440	± 10%	16,8	61,2
AC 50/60 Hz voltage version					
024AC	24	400	± 10%	19,2	28,8
230AC	230	38 500	± 10%	184,0	276,0

Dimensions

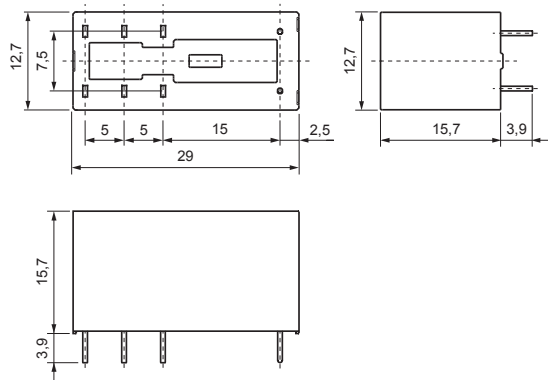

Connection diagram (pin side view)

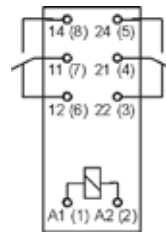

Terminal (pin)	A1(1); A2(2)	22(3); 21(4); 24(5); 12(6); 11(7); 14(8)
[mm]	Ø 0,6	0,5 x 0,9
Drilling hole:		
• for relays Ø 1,3 + 0,1 mm		
• for sockets Ø 1,5 + 0,1 mm		

Electrical life at AC resistive load.
Switching frequency: 600 cycles/hour

Fig. 1

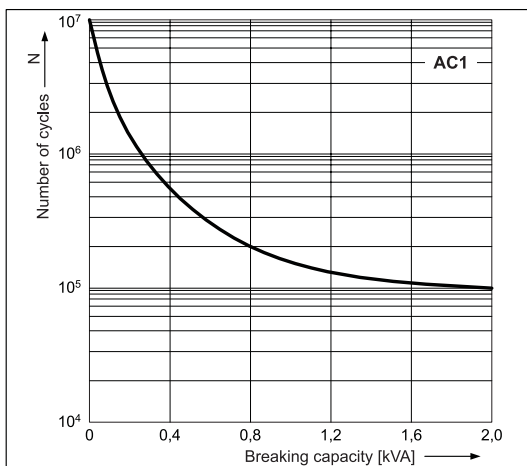

Electrical life reduction factor at AC inductive load

Fig. 2

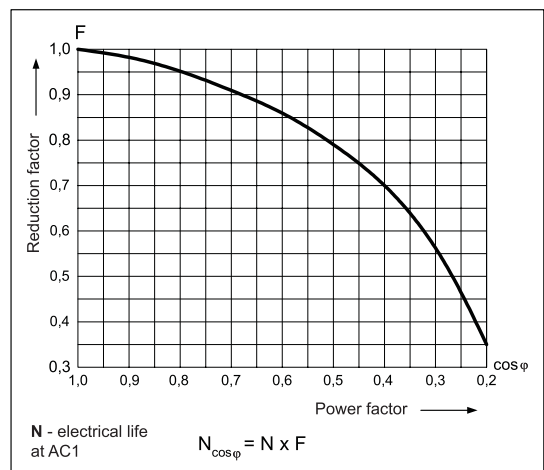

Max. DC resistive load breaking capacity

Fig. 3

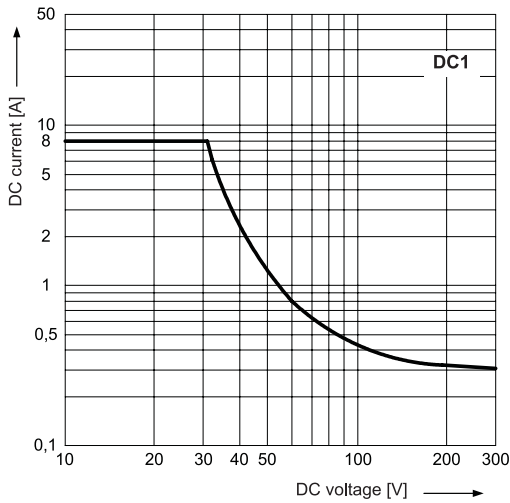

Coil operating range = DC

Fig. 4

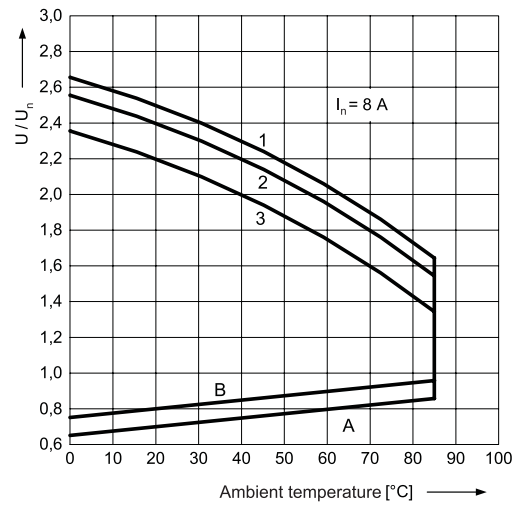

Coil operating range = AC 50 Hz

Fig. 5

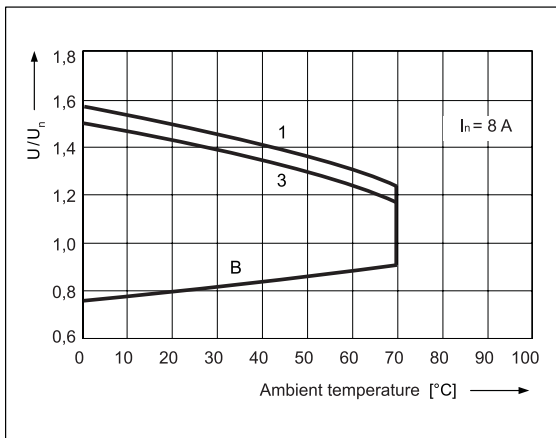

Description of Fig. 4 and 5

A - relations between make voltage and ambient temperature at no load on contacts. Coil temperature and ambient temperature are equal before coil energizing. Make voltage is not higher than the value read on Y axis (multiplication of rated voltage).

B - relations between make voltage and ambient temperature after initial coil heating up with $1,1 U_n$, at continues load of I_n on contacts. Make voltage is not higher than the value read on Y axis (multiplication of rated voltage).

1, 2, 3 - values on Y axis represent allowed overvoltage on coil at certain ambient temperature and contact load:

- 1** - no load
- 2** - 50% of rated load
- 3** - rated load

Pinout (soldier side view)

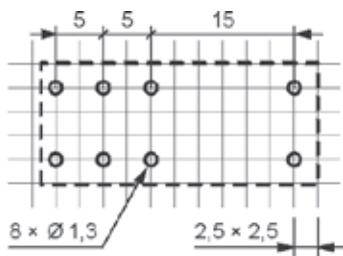

Mounting

Relays MER2 are designed for:

- direct PCB mounting
- screw terminals plug-in sockets MERB-T and MERB-M

Plugin Sockets And Accessories

MERB-T

Plugin sockets (base) type T

- Screw terminals
- Max. tightening moment for the terminal: 0,7 Nm
- 35 mm rail mount acc. to EN 60715
- or on panel mounting
- 75,3 x 15,5 x 61(67) mm*

*In the bracket the height of socket with retainer / retractor clip is shown.

MERB-M

Plugin sockets (base) type M

- Screw terminals
- Max. tightening moment for the terminal: 0,7 Nm
- 35 mm rail mount acc. to EN 60715
- or on panel mounting
- 78,1 x 15,9 x 61(66,5) mm*

*In the bracket the height of socket with retainer / retractor clip is shown.

Two poles, 5mm pinout

12A, 300 V AC

Dimensions

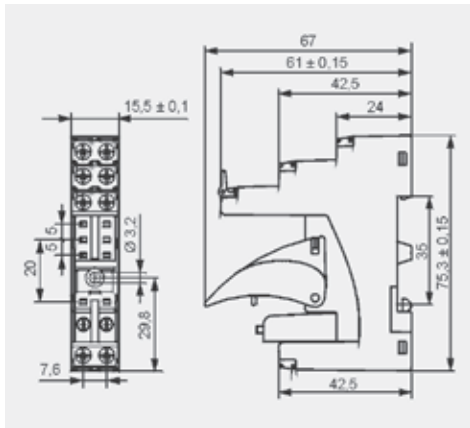

Two poles, 5mm pinout

12A, 300 V AC

Dimensions

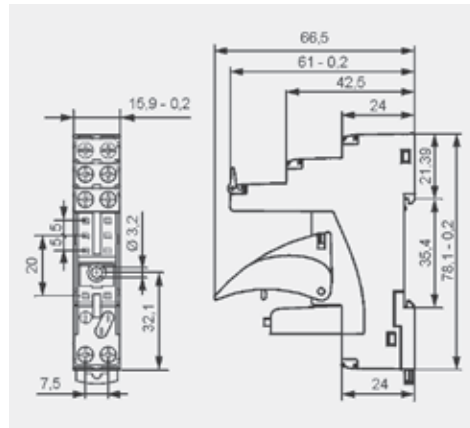

Connection diagram

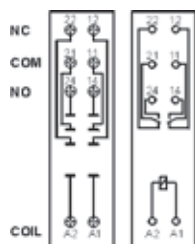

Connection diagram

